

GRAND MELLOW

ZEITRAUM

assembly instructions 07/2021

TOOLS:

allen key SW4 and SW5 (enclosed)

12 x XS steel bolts



12 x connector housings



12 x grub screws



24 x confirmat screws (5x50)



2 x countersunk screws (M8x50)

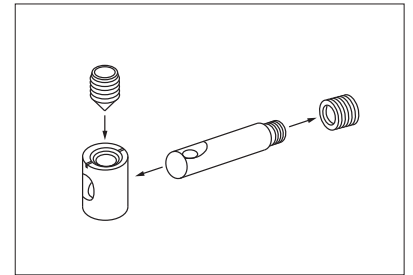

Watch this video for further information on the metal fitting:
<https://www.youtube.com/watch?v=ioiUTDqtvgE>

Please assemble the bed **on a soft surface (e.g. a carpet or blanket)** to avoid damages.

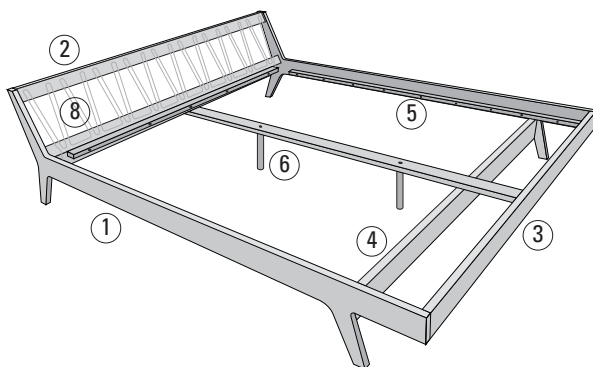

- 1 side rails
- 2 headboard
- 3 footboard
- 4 cross bar

- 5 support bars
- 6 center rail and center feet
- 7 leather cord

- 1. Screw steel bolts into the side rails (1). Insert connector housings into headboard (2), footboard (3) and cross bar (4). Ensure that bolts and housings are aligned correctly.

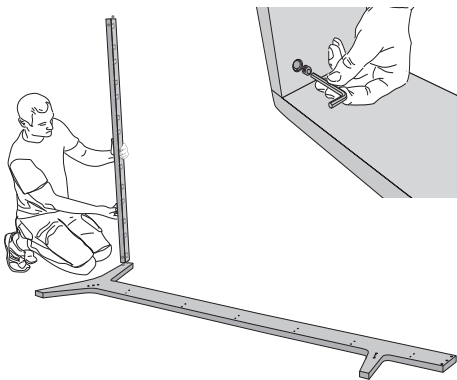

- 2. Place the bars of the headboard (2) on one of the side rails (1) and fix the connectors using the allen key.

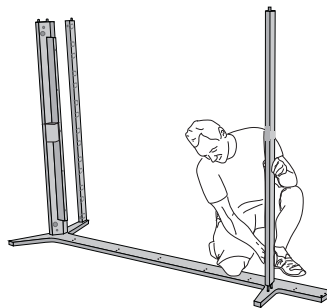

- 3. Attach the cross bar (4) to the side rail (1).

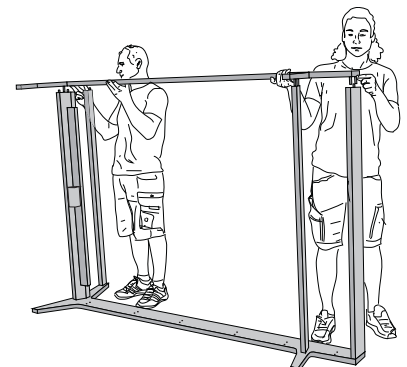

- 4. Attach the footboard (3) to the side rail (1). Place the second side rail on top of the parts that are already assembled.

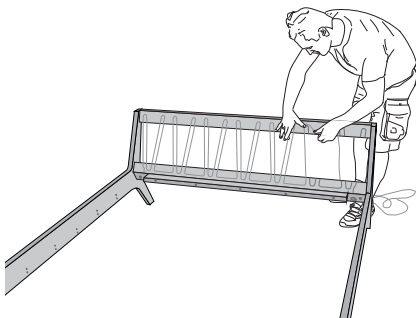

- 5. Thread the leather cord (8) through the slots in the headboard (2). Before fixing it, tighten the cord slightly.

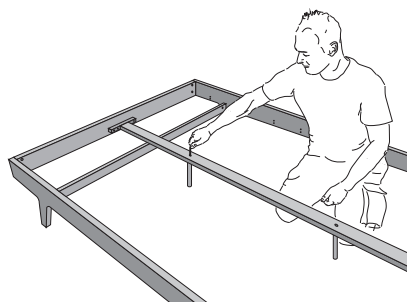

- 6. Attach the center rail (6) and fasten the center feet to the center rail.

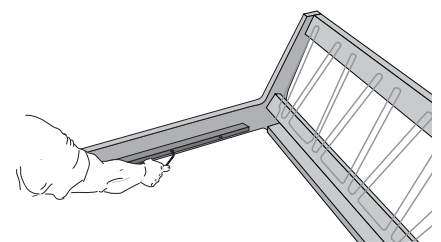

- 7. Attach the support bars (5) to the side rails (1) using confirmat crews.