

IN HEAVEN Wooden headboard

Assembly instructions 01.2022

9.

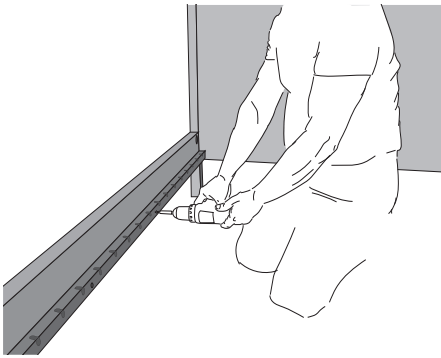

Push the support bars **(5)** onto the holes in the side rails **(4)** and secure them with Spax screws.

10.

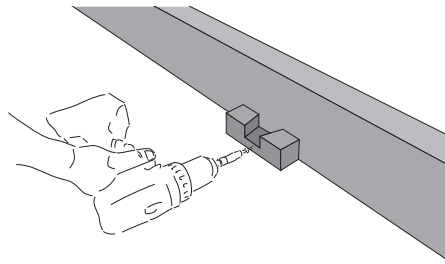

Push the center support blocks onto headboard **(1)** and footboard **(3)**. Use Spax screws to secure them.

10.

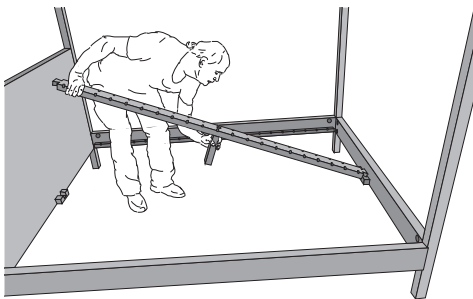

Attach the center support foot **(8)** to the center rail **(5)**. Place the center rail on the center support blocks.

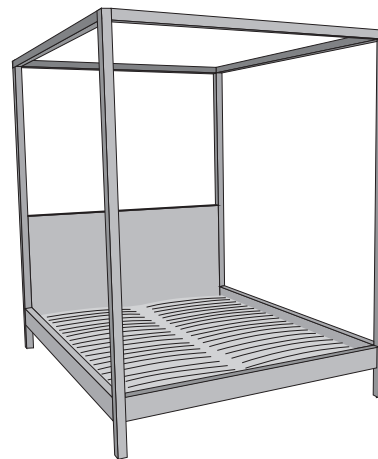

TOOLS:

allen key (enclosed)
cordless drill driver
open-end wrench size 10
ladder

16 × Maxifix connector housings



16 × Maxifix bolts



8 × frame connectors



8 × cylinder head screws (M8x25)



with flat washers

10 × Spax screws (5x50)

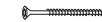

Please assemble the bed **on a soft surface (e.g. a carpet or blanket)** to avoid damages.

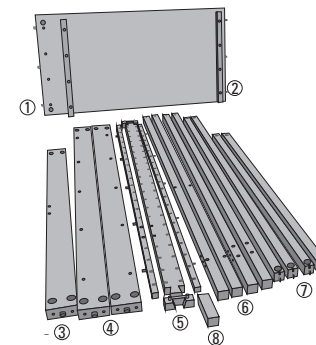

- 1 headboard
- 2 vertical bars
- 3 footboard
- 4 side rails
- 5 center rail and support bars
- 6 corner posts
- 7 upper frame
- 8 center support foot

1.

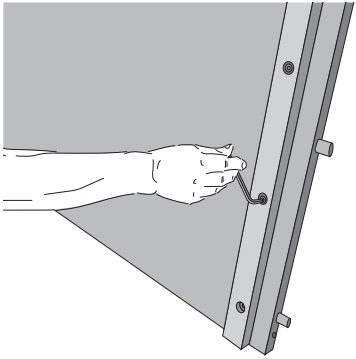

Loosen the screws of the vertical bars **(2)** at the headboard **(1)** and put the bars aside.

2.

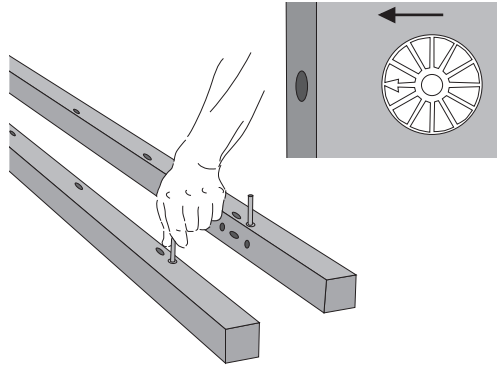

Screw the Maxifix bolts into the corner posts **(6)**. Insert the connector housings into side rails **(4)**, headboard **(1)** and footboard **(3)**. When aligning the housings, ensure that the arrow points towards the intersecting hole.

5.

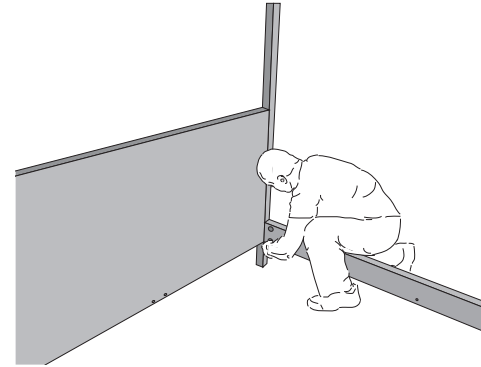

Attach the side rails **(4)** to the headboard **(1)**.

6.

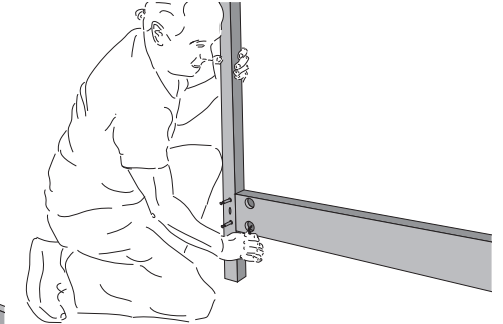

Fix the corner posts **(6)** to the footboard **(3)**.

3.

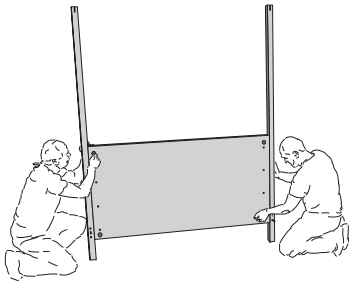

Push the headboard **(1)** onto the Maxifix bolts of the corner posts **(6)** and tighten the connectors using the allen key.

4.

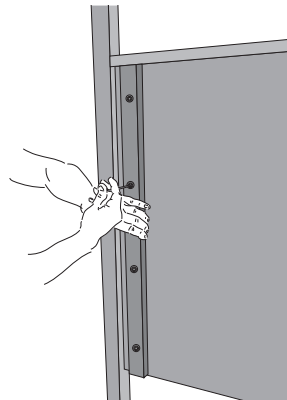

Reattach the vertical bars.

7.

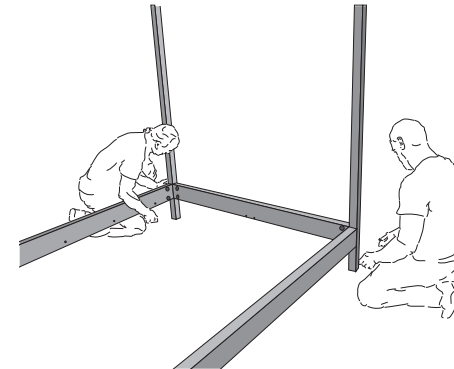

Attach the footboard **(3)** to the side rails **(4)**.

8.

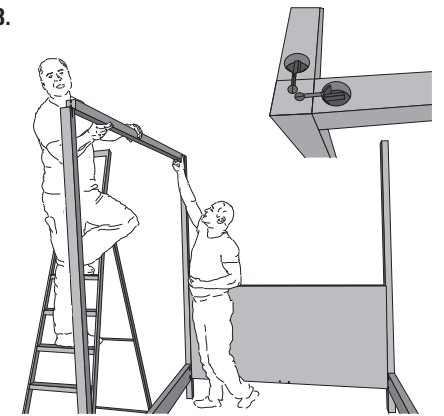

Place the bars of the upper frame **(7)** in between the corner posts **(6)** and secure them with frame connectors. Tighten the connectors using an open-end wrench.