









Assembly instructions 07/2022

TOOLS:

Allen key SW4 and SW5 (enclosed), crosstip screwdriver

| | | | |
|----------------------------|---|-------------------------------------|--|
| 14 x XS steel dowels |  | 3x distance blocks (100x60x40) | |
| 14 x connector housings |  | 3 x center support feet, adjustable | |
| 14 x grub screws |  | 8 x cylinder head screws (M6x80) |  |
| 24 x Confirmat screws |  | with flat washers | |
| 3 x sleeve nuts (M8) |  | 4 x wooden mounting blocks | |
| 3 x threaded rods (M8x70) |  | 4 x flat head screws (M6x60) |  |
| 3 x threaded rods (M8x215) |  | | |

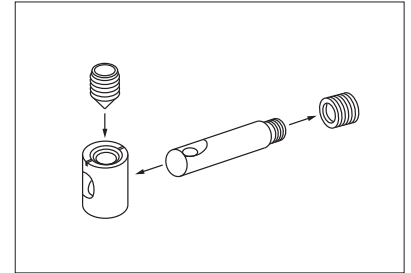

Watch this video for further information on the metal fitting:
<https://www.youtube.com/watch?v=ioiUTDqtvgE>

Please assemble the bed **on a soft surface (e.g. a carpet or blanket)** to avoid damages.

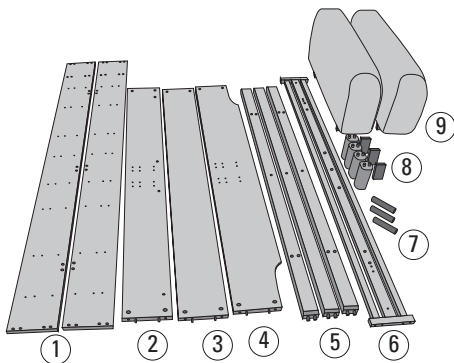

- 1 side rails
- 2 upholstery bar
- 3 headboard
- 4 footboard
- 5 crossbars
- 6 center rail and support bars
- 7 bed and center support feet
- 8 distance blocks
- 9 cushions with mounting blocks

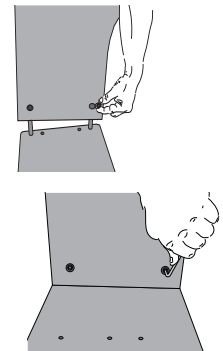
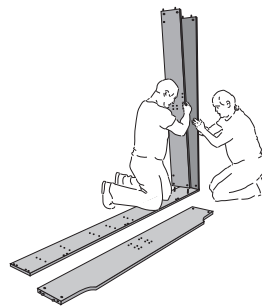

1. Screw XS dowels into side rails (1) and insert the connector housings into the holes. Align dowels and housings correctly! Mount headboard (3) and footboard (4) as well as the upholstery bar (2) to the side rail and fix the connection with grub screws.



2. Place the bed feet (7) on the crossbars (5). Mount the crossbars to the side rail. Fix the center cross bar with XS connectors. Mount the second side rail.

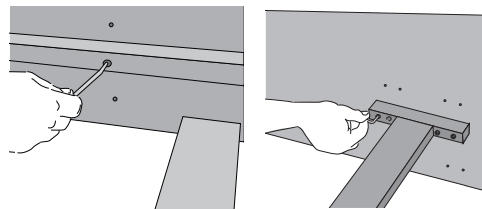

3. Mount the center rail and the support bars (6) using Confirmat screws.

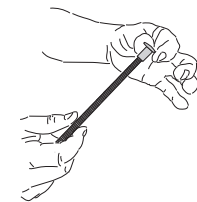

4. Screw the sleeve nuts onto the threaded rods (short threaded rods only for lowest position).

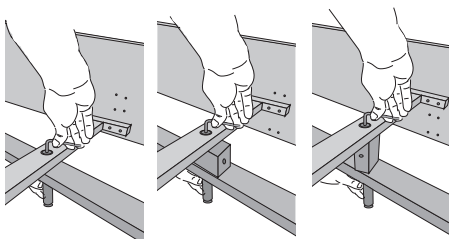

without distance block: insertion depth 16,5 cm
 horizontal distance block: insertion depth 10,5 cm
 vertical distance block: insertion depth 6,5 cm

5. Choose the position of the distance blocks (8) according to the insertion depth. Position the center support feet under the crossbars and screw in the threaded rods while holding the center support feet. Adjust the height of the center support feet.

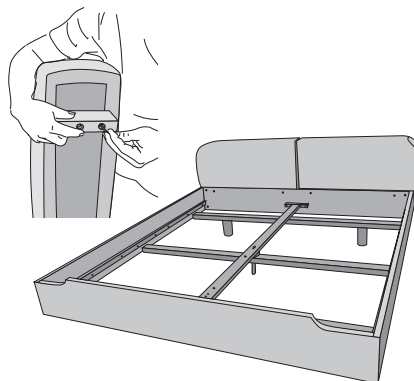

6. Attach the mounting blocks to the bottom of the cushion (9) with cylinder head screws. Insert the cushions between upholstery bar and headboard the soft side of the cushion facing towards the front.

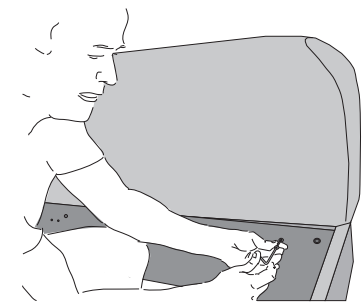

7. Fix the cushions using flat head screws (M6).