

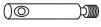





## Assembly instructions 04/2022

### TOOLS:

allen key SW4 und SW5 (enclosed), crosstip screwdriver

14x XS steel dowels		3x sleeve nuts (M8)	
14x connector housings		3x threaded rods (M8)	
14x grub screws		3x center support feet, adjustable	
24x Confirmat screws		3x distance blocks (100x60x40)	
3x countersunk bolts (M8x80)		3x distance blocks (40x60x40)	

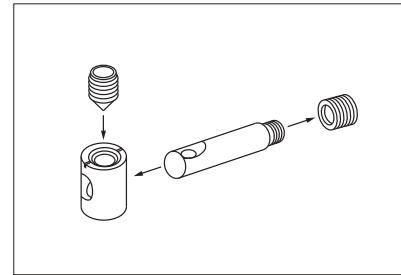

Watch this video for further information on the metal fitting:  
<https://www.youtube.com/watch?v=ioiUTDqtvgE>

Please assemble the bed **on a soft surface (e.g. a carpet or blanket)** to avoid damages.

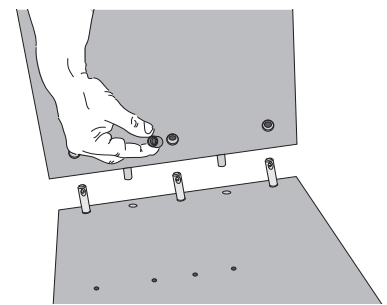
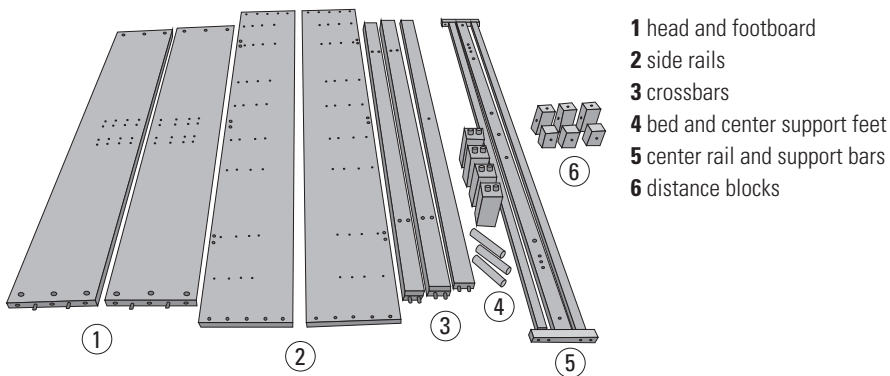

**1.** Screw the XS dowels into the side rails (2) and insert the connector housings into head and footboard (1). Align dowels and housings correctly!

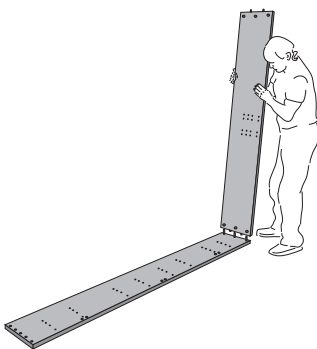

**2.** Attach the head and footboard to the side rail and fix them with grub screws.



**3.** Attach the bed feet to the crossbars. Mount the crossbars to the bed side. Fix the center crossbar with XS connectors.

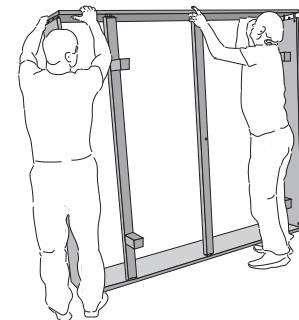

**4.** Connect the second side rail and fix it with grub screws.

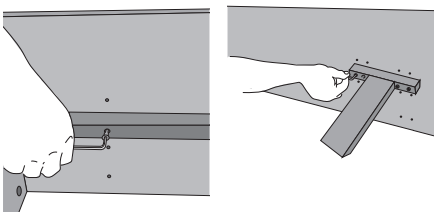

**5.** Fix the support bars and center rail using Confirmat screws.

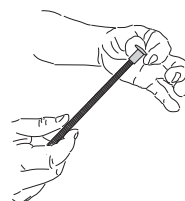

**6.** Screw the sleeve nuts onto the threaded rods. Choose the right distance blocks (6) according to the insertion depth. Position the center support feet under the crossbars and screw in the threaded rods (or the countersunk bolts for the lowest insertion depth) while holding the center support feet. Adjust the height of the center support feet.

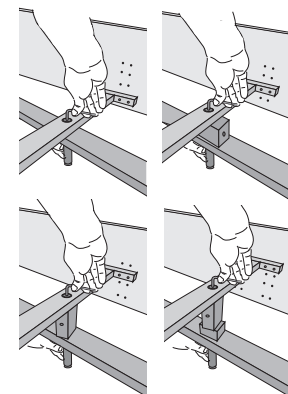

without distance block: insertion depth 24,5 cm  
 horizontal big distance block: insertion depth 18,5 cm  
 vertical big distance block: insertion depth 14,5 cm  
 both distance blocks: insertion depth 10,5 cm